

# KINTEK®

## SHRINK FIT CHUCKS

### MANDRINI A CALETTAMENTO



08



[www.kintek.it](http://www.kintek.it)

**SHRINK  
FIT CHUCKS** 

MANDRINI  
A CALETTAMENTO 

SCHRUMPFUTTER 

MANDRINS  
DE FRETTAGE 

ТЕРМОЗАЖИМНЫЕ  
ПАТРОНЫ 

热缩刀柄 



# SHRINK FIT CHUCKS

DIN 69871

MAS 403/BT

DIN 69893



SHRINK FIT CHUCKS ISO 40 DIN 69871 AD/B  
 SCHRUMPFUTTER ISO 40 DIN 69871 AD/B  
 ТЕРМОЗАЖИМНЫЕ ПАТРОНЫ ISO 40 ПО DIN 69871 ТИП AD/B

MANDRINI A CALETTAMENTO ISO 40 DIN 69871 AD/B  
 MANDRINS DE FRETTAGE TYPE ISO 40 DIN 69871 AD/B  
 热缩刀柄 ISO 40 DIN 69871 AD/B

## DIN 69871 AD/B

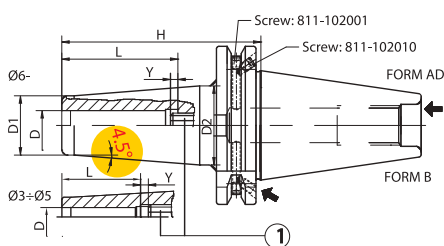

### 4.5° PROGRAMME

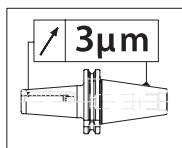

	CODE N.	DESCRIPTION	D	H	L	Ymax	D1	D2	G2,5 25000
STANDARD	251-11232	TC40H80K03-HTT	3	80	22	10	10	17	•
	251-11225	TC40H80K04-HTT	4	80	26	10	15	22	•
	251-11233	TC40H80K05-HTT	5	80	30	10	15	22	•
	251-11201	TC40H80K06-HTT	6	80	36	10	21	27	•
	251-11202	TC40H80K08-HTT	8	80	36	10	21	27	•
	251-11203	TC40H80K10-HTT	10	80	41	10	24	32	•
	251-11204	TC40H80K12-HTT	12	80	47	10	24	32	•
	251-11206	TC40H80K14-HTT	14	80	47	10	27	34	•
	251-11205	TC40H80K16-HTT	16	80	50	10	27	34	•
	251-11207	TC40H80K18-HTT	18	80	50	10	33	42	•
	251-11208	TC40H80K20-HTT	20	80	52	10	33	42	•
	251-11218	TC40H100K25-HTT	25	100	58	10	44	53	•
251-21233	TC40H100K32-HTT	32	100	62	10	44	53	•	
H 120	251-11295	TC40H120K03-HTT	3	120	22	10	10	20	•
	251-11296	TC40H120K04-HTT	4	120	26	10	15	22	•
	251-11297	TC40H120K05-HTT	5	120	30	10	15	22	•
	251-11209	TC40H120K06-HTT	6	120	36	10	21	27	•
	251-11210	TC40H120K08-HTT	8	120	36	10	21	27	•
	251-11211	TC40H120K10-HTT	10	120	41	10	24	32	•
	251-11212	TC40H120K12-HTT	12	120	47	10	24	32	•
	251-11298	TC40H120K16-HTT	16	120	50	10	27	34	•
	251-21235	TC40H120K20-HTT	20	120	52	10	33	42	•
	251-21236	TC40H120K25-HTT	25	120	58	10	44	53	•
H 160	251-21238	TC40H160K03-HTT	3	160	22	10	10	20	•
	251-21239	TC40H160K04-HTT	4	160	26	10	15	22	•
	251-21240	TC40H160K05-HTT	5	160	30	10	15	22	•
	251-21241	TC40H160K06-HTT	6	160	36	10	21	27	•
	251-21242	TC40H160K08-HTT	8	160	36	10	21	27	•
	251-21243	TC40H160K10-HTT	10	160	41	10	24	32	•
	251-21244	TC40H160K12-HTT	12	160	47	10	24	32	•
	251-21246	TC40H160K16-HTT	16	160	50	10	27	34	•
	251-21248	TC40H160K20-HTT	20	160	52	10	33	42	•
	251-21249	TC40H160K25-HTT	25	160	62	10	44	53	•

SHRINK FIT CHUCKS ISO 40 DIN 69871 AD/B  
 SCHRUMPFUTTER ISO 40 DIN 69871 AD/B  
 ТЕРМОЗАЖИМНЫЕ ПАТРОНЫ ISO 40 ПО DIN 69871 ТИП AD/B

MANDRINI A CALETTAMENTO ISO 40 DIN 69871 AD/B  
 MANDRINS DE FRETTAGE TYPE ISO 40 DIN 69871 AD/B  
 热缩刀柄 ISO 40 DIN 69871 AD/B

## DIN69871

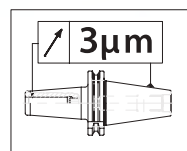
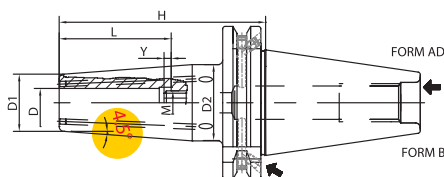

### 4,5° PROGRAMME WITH RESEALABLE COOLANT DUCT HOLES 4,5° CON PASSAGGIO REFRIGERANTE MEDIANTE CANALI ESTERNI RICHIUDIBILI

	CODE N.	DESCRIPTION	D	H	L	Ymax	D1	D2	M	SW	G2,5 25000
STANDARD	251-31218	TC40H80K03-HTT-L	3	80	28	16	10	17	M6	2	•
	251-31219	TC40H80K04-HTT-L	4	80	28	12	15	22	M6	2	•
	251-31220	TC40H80K05-HTT-L	5	80	30	10	15	22	M6	2	•
	251-31221	TC40H80K06-HTT-L	6	80	36	10	21	27	M5	2,5	•
	251-31222	TC40H80K08-HTT-L	8	80	36	10	21	27	M6	3	•
	251-31223	TC40H80K10-HTT-L	10	80	41	10	24	32	M8x1	3	•
	251-31224	TC40H80K12-HTT-L	12	80	47	10	24	32	M10x1	5	•
	251-31225	TC40H80K14-HTT-L	14	80	47	10	27	34	M10x1	5	•
	251-31226	TC40H80K16-HTT-L	16	80	50	10	27	34	M12x1	5	•
	251-31227	TC40H80K18-HTT-L	18	80	50	10	33	42	M12x1_KKB	5	•
	251-31228	TC40H80K20-HTT-L	20	80	52	10	33	42	M16x1_KKB	5	•
	251-31229	TC40H100K25-HTT-L	25	100	58	10	44	53	M16x1	8	•
	251-31230	TC40H100K32-HTT-L	32	100	62	10	44	53	M16x1_KKB	5	•

SHRINK FIT CHUCKS ISO 40 DIN 69871 AD/B MANDRINI A CALETTAMENTO ISO 40 DIN 69871 AD/B  
 SCHRUMPFUTTER ISO 40 DIN 69871 AD/B MANDRINS DE FRETTAGE TYPE ISO 40 DIN 69871 AD/B  
 ТЕРМОЗАЖИМНЫЕ ПАТРОНЫ ISO 40 ПО DIN 69871 ТИП AD/B 热缩刀柄 ISO 40 DIN 69871 AD/B

### DIN69871

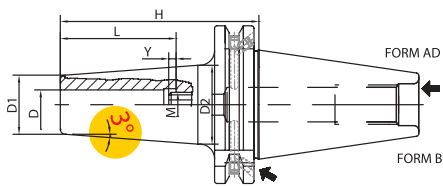

**3° PROGRAMME**

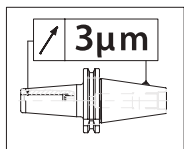

CODE N.	DESCRIPTION	D	H	L	Y <sub>max</sub>	D1	D2	M	SW	G2,5 25000
251-21284	TC40H80K03-HTT	3	80	28	16	9	14	M6	2	•
251-21285	TC40H80K04-HTT	4	80	28	12	10	15	M6	2	•
251-21286	TC40H80K05-HTT	5	80	30	10	11	16	M6	2	•
251-21287	TC40H80K06-HTT	6	80	36	10	12	17	M5	2,5	•
251-21288	TC40H80K08-HTT	8	80	36	10	14	19	M6	3	•
251-21289	TC40H80K10-HTT	10	80	41	10	16	21	M8x1	3	•
251-21290	TC40H80K12-HTT	12	80	47	10	18	23	M10x1	5	•
251-21291	TC40H80K14-HTT	14	80	47	10	20	26	M10x1	5	•
251-21292	TC40H80K16-HTT	16	80	50	10	22	28	M12x1	5	•
251-21293	TC40H80K18-HTT	18	80	50	10	24	30	M12x1	5	•
251-21294	TC40H80K20-HTT	20	80	52	10	26	32	M16x1	8	•

STANDARD

08

SHRINK FIT CHUCKS ISO 40 DIN 69871 AD/B MANDRINI A CALETTAMENTO ISO 40 DIN 69871 AD/B  
 SCHRUMPFUTTER ISO 40 DIN 69871 AD/B MANDRINS DE FRETTAGE TYPE ISO 40 DIN 69871 AD/B  
 ТЕРМОЗАЖИМНЫЕ ПАТРОНЫ ISO 40 ПО DIN 69871 ТИП AD/B 热缩刀柄 ISO 40 DIN 69871 AD/B

### DIN69871

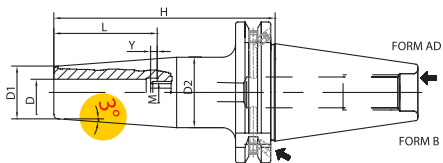

**3° PROGRAMME**

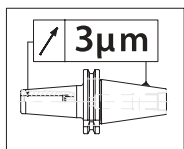

CODE N.	DESCRIPTION	D	H	L	Y <sub>max</sub>	D1	D2	M	SW	G2,5 25000
251-21295	TC40H120K03-HTT	3	120	12	-	9	16	-	-	•
251-21296	TC40H120K04-HTT	4	120	16	-	10	17	-	-	•
251-21297	TC40H120K05-HTT	5	120	20	-	11	18	-	-	•
251-21298	TC40H120K06-HTT	6	120	36	10	12	22	M5	2,5	•
251-21299	TC40H120K08-HTT	8	120	36	10	14	24	M6	3	•
251-31201	TC40H120K10-HTT	10	120	41	10	16	26	M8x1	3	•
251-31202	TC40H120K12-HTT	12	120	47	10	18	28	M10x1	5	•
251-31203	TC40H120K14-HTT	14	120	47	10	20	30	M10x1	5	•
251-31204	TC40H120K16-HTT	16	120	50	10	22	32	M12x1	5	•
251-31205	TC40H120K18-HTT	18	120	50	10	24	34	M12x1	5	•
251-31206	TC40H120K20-HTT	20	120	52	10	26	36	M16x1	8	•

H120

CODE N.	DESCRIPTION	D	H	L	Y <sub>max</sub>	D1	D2	M	SW	G2,5 25000
251-31207	TC40H160K03-HTT	3	160	12	-	9	19	-	-	•
251-31208	TC40H160K04-HTT	4	160	16	-	10	20	-	-	•
251-31209	TC40H160K05-HTT	5	160	20	-	11	21	-	-	•
251-31210	TC40H160K06-HTT	6	160	36	10	12	24	M5	2,5	•
251-31211	TC40H160K08-HTT	8	160	36	10	14	26	M6	3	•
251-31212	TC40H160K10-HTT	10	160	41	10	16	28	M8x1	3	•
251-31213	TC40H160K12-HTT	12	160	47	10	18	30	M10x1	5	•
251-31214	TC40H160K14-HTT	14	160	47	10	20	32	M10x1	5	•
251-31215	TC40H160K16-HTT	16	160	50	10	22	34	M12x1	5	•
251-31216	TC40H160K18-HTT	18	160	50	10	24	36	M12x1	5	•
251-31217	TC40H160K20-HTT	20	160	52	10	26	38	M16x1	8	•

H160

SHRINK FIT CHUCKS ISO 50 DIN 69871 AD/B MANDRINI A CALETTAMENTO ISO 50 DIN 69871 AD/B  
 SCHRUMPFUTTER ISO 50 DIN 69871 AD/B MANDRINS DE FRETTAGE TYPE ISO 50 DIN 69871 AD/B  
 ТЕРМОЗАЖИМНЫЕ ПАТРОНЫ ISO 50 ПО DIN 69871 ТИП AD/B 热缩刀柄 ISO 50 DIN 69871 AD/B

## DIN 69871 AD/B

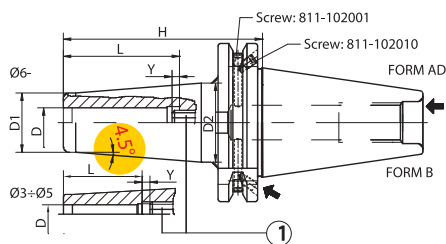

**4.5° PROGRAMME**

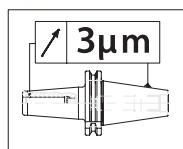

	CODE N.	DESCRIPTION	D	H	L	Y <sub>max</sub>	D1	D2	G2,5 25000
STANDARD	251-21251	TC50H80K03-HTT	3	80	-	-	10	20	•
	251-21252	TC50H80K04-HTT	4	80	-	-	15	25	•
	251-21253	TC50H80K05-HTT	5	80	-	-	15	25	•
	251-11234	TC50H80K06-HTT	6	80	36	10	21	27	•
	251-11235	TC50H80K08-HTT	8	80	36	10	21	27	•
	251-11236	TC50H80K10-HTT	10	80	41	10	24	32	•
	251-11237	TC50H80K12-HTT	12	80	47	10	24	32	•
	251-11224	TC50H80K16-HTT	16	80	50	10	27	34	•
	251-11240	TC50H80K20-HTT	20	80	52	10	33	42	•
	251-11241	TC50H100K25-HTT	25	100	58	10	44	53	•
251-21254	TC50H100K32-HTT	32	100	62	10	44	53	•	
H120	251-11242	TC50H120K06-HTT	6	120	36	10	21	27	•
	251-11243	TC50H120K08-HTT	8	120	36	10	21	27	•
	251-11244	TC50H120K10-HTT	10	120	41	10	24	32	•
	251-11245	TC50H120K12-HTT	12	120	47	10	24	32	•
	251-11246	TC50H120K14-HTT	14	120	47	10	27	34	•
	251-11247	TC50H120K16-HTT	16	120	50	10	27	34	•
	251-11248	TC50H120K18-HTT	18	120	50	10	33	42	•
	251-11249	TC50H120K20-HTT	20	120	52	10	33	42	•
251-21258	TC50H120K25-HTT	25	120	58	10	44	53	•	
H160	251-21263	TC50H160K06-HTT	6	160	36	10	21	27	•
	251-21264	TC50H160K08-HTT	8	160	36	10	21	27	•
	251-21265	TC50H160K10-HTT	10	160	41	10	24	32	•
	251-21266	TC50H160K12-HTT	12	160	47	10	24	32	•
	251-21267	TC50H160K14-HTT	14	160	47	10	27	34	•
	251-21268	TC50H160K16-HTT	16	160	50	10	27	34	•
	251-21269	TC50H160K18-HTT	18	160	50	10	33	42	•
	251-21270	TC50H160K20-HTT	20	160	52	10	33	42	•
251-21271	TC50H160K25-HTT	25	160	58	10	44	53	•	

08

SHRINK FIT CHUCKS MAS BT-30 FORM AD MANDRINI A CALETTAMENTO MAS BT-30 FORM AD  
 SCHRUMPFUTTER MAS BT-30 FORM AD MANDRINS DE FRETTAGE TYPE MAS BT-30 FORM AD  
 ТЕРМОЗАЖИМНЫЕ ПАТРОНЫ MAS BT-30 ТИП AD 热缩刀柄 MAS BT30 AD 型

## JIS-B 6339 MAS 403 BT-AD - MAS BT-AD

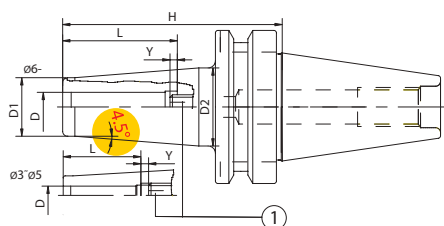

**4.5° PROGRAMME**

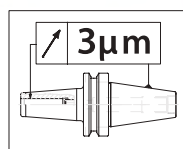

	CODE N.	DESCRIPTION	D	H	L	Y <sub>max</sub>	D1	D2	G2,5 25000
STANDARD	251-11564	BT30H85K03-HTT	3	85	22	10	10	20	•
	251-11565	BT30H85K04-HTT	4	85	26	10	15	25	•
	251-11566	BT30H85K05-HTT	5	85	30	10	15	25	•
	251-11567	BT30H85K06-HTT	6	85	36	10	21	27	•
	251-11568	BT30H85K08-HTT	8	85	36	10	21	27	•
	251-11569	BT30H85K10-HTT	10	85	41	10	24	32	•
	251-11570	BT30H85K12-HTT	12	85	47	10	24	32	•
	251-11571	BT30H85K14-HTT	14	85	47	10	27	34	•
	251-11572	BT30H85K16-HTT	16	85	50	10	27	34	•
	251-11588	BT30H85K18-HTT	18	85	50	10	33	42	•
251-11589	BT30H85K20-HTT	20	85	50	10	33	42	•	

SHRINK FIT CHUCKS MAS BT40 AD/B MANDRINI A CALETTAMENTO MAS BT40 TIPO AD/B  
 SCHRUMPFUTTER MAS BT40 FORM AD/B MANDRINS DE FRETTAGE MAS BT40 TYPE AD/B  
 ТЕРМОЗАЖИМНЫЕ ПАТРОНЫ MAS BT-40 ТИП AD/B 热缩刀柄 MAS BT40 AD/B

**JIS-B 6339 MAS 403 BT-AD/B - MAS BT AD/B**

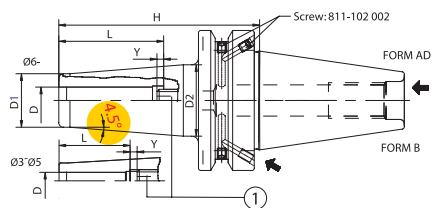

**4.5° PROGRAMME**

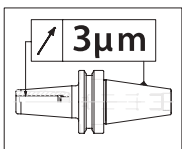

	CODE N.	DESCRIPTION	D	H	L	Y <sub>max</sub>	D1	D2	G2,5 25000
STANDARD	251-11580	BT40H90K03-HTT	3	90	22	10	10	17	•
	251-11581	BT40H90K04-HTT	4	90	26	10	15	22	•
	251-11582	BT40H90K05-HTT	5	90	30	10	15	22	•
	251-11501	BT40H90K06-HTT	6	90	36	10	21	27	•
	251-11502	BT40H90K08-HTT	8	90	36	10	21	27	•
	251-11503	BT40H90K10-HTT	10	90	41	10	24	32	•
	251-11504	BT40H90K12-HTT	12	90	47	10	24	32	•
	251-11505	BT40H90K14-HTT	14	90	47	10	27	34	•
	251-11506	BT40H90K16-HTT	16	90	50	10	27	34	•
	251-11507	BT40H90K18-HTT	18	90	50	10	33	42	•
251-11508	BT40H90K20-HTT	20	90	52	10	33	42	•	
251-11547	BT40H100K25-HTT	25	100	58	10	44	53	•	
H120	251-11583	BT40H120K03-HTT	3	120	22	10	10	20	•
	251-11584	BT40H120K04-HTT	4	120	26	10	15	22	•
	251-11585	BT40H120K05-HTT	5	120	30	10	15	22	•
	251-11509	BT40H120K06-HTT	6	120	36	10	21	27	•
	251-11510	BT40H120K08-HTT	8	120	36	10	21	27	•
	251-11511	BT40H120K10-HTT	10	120	41	10	24	32	•
	251-11512	BT40H120K12-HTT	12	120	47	10	24	32	•
	251-11586	BT40H120K16-HTT	16	120	50	10	27	34	•
	251-21505	BT40H120K18-HTT	18	120	50	10	33	42	•
	251-21506	BT40H120K20-HTT	20	120	52	10	33	42	•
251-21507	BT40H120K25-HTT	25	120	58	10	44	53	•	
251-21508	BT40H120K32-HTT	32	120	62	10	44	53	•	
H160	251-21509	BT40H160K03-HTT	3	160	22	10	10	20	•
	251-21510	BT40H160K04-HTT	4	160	26	10	15	22	•
	251-21512	BT40H160K06-HTT	6	160	36	10	21	27	•
	251-21513	BT40H160K08-HTT	8	160	36	10	21	27	•
	251-21514	BT40H160K10-HTT	10	160	41	10	24	32	•
	251-21515	BT40H160K12-HTT	12	160	47	10	24	32	•
	251-21517	BT40H160K16-HTT	16	160	50	10	27	34	•
	251-21519	BT40H160K20-HTT	20	160	52	10	33	42	•
251-21520	BT40H160K25-HTT	25	160	58	10	44	53	•	

08

SHRINK FIT CHUCKS MAS BT40 AD/B MANDRINI A CALETTAMENTO MAS BT40 TIPO AD/B  
 SCHRUMPFUTTER MAS BT40 FORM AD/B MANDRINS DE FRETTAGE MAS BT40 TYPE AD/B  
 ТЕРМОЗАЖИМНЫЕ ПАТРОНЫ MAS BT-40 ТИП AD/B 热缩刀柄 MAS BT40 AD/B

**JIS-B 6339 MAS 403 BT-AD/B - MAS BT**

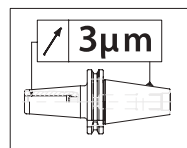
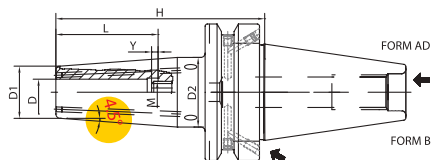

**4,5° PROGRAMME WITH RESEALABLE COOLANT DUCT HOLES**  
**4,5° CON PASSAGGIO REFRIGERANTE MEDIANTE CANALI ESTERNI RICHIUDIBILI**

	CODE N.	DESCRIPTION	D	H	L	Y <sub>max</sub>	D1	D2	M	SW	G2,5 25000
STANDARD	251-21579	BT40H90K03-HTT-L	3	90	28	16	10	17	M6	2	•
	251-21580	BT40H90K04-HTT-L	4	90	28	12	15	22	M6	2	•
	251-21581	BT40H90K05-HTT-L	5	90	30	10	15	22	M6	2	•
	251-21582	BT40H90K06-HTT-L	6	90	36	10	21	27	M5	2,5	•
	251-21583	BT40H90K08-HTT-L	8	90	36	10	21	27	M6	3	•
	251-21584	BT40H90K10-HTT-L	10	90	41	10	24	32	M8x1	3	•
	251-21585	BT40H90K12-HTT-L	12	90	47	10	24	32	M10x1_KKB	5	•
	251-21586	BT40H90K14-HTT-L	14	90	47	10	27	34	M10x1_KKB	5	•
	251-21587	BT40H90K16-HTT-L	16	90	50	10	27	34	M12x1_KKB	5	•
	251-21588	BT40H90K18-HTT-L	18	90	50	10	33	42	M12x1_KKB	5	•
	251-21589	BT40H90K20-HTT-L	20	90	52	10	33	42	M16x1_KKB	5	•
	251-21590	BT40H100K25-HTT-L	25	100	58	10	44	53	M16x1_KKB	5	•
	251-21591	BT40H100K32-HTT-L	32	100	62	10	44	53	M16x1_KKB	5	•

SHRINK FIT CHUCKS MAS BT40 AD/B MANDRINI A CALETTAMENTO MAS BT40 TIPO AD/B  
 SCHRUMPFUTTER MAS BT40 FORM AD/B MANDRINS DE FRETTAGE MAS BT40 TYPE AD/B  
 ТЕРМОЗАЖИМНЫЕ ПАТРОНЫ MAS BT-40 ТИП AD/B 热缩刀柄 MAS BT40 AD/B

**JIS-B 6339 MAS 403 BT-AD/B - MAS BT**

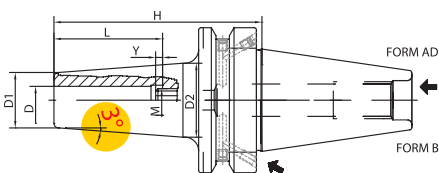

**3° PROGRAMME**

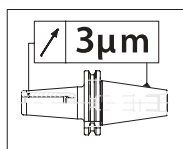

CODE N.	DESCRIPTION	D	H	L	Y <sub>max</sub>	D1	D2	M	SW	G2,5 25000
251-21546	BT40H90K03-HTT	3	90	28	16	9	15	M6	2	•
251-21547	BT40H90K04-HTT	4	90	28	12	10	16	M6	2	•
251-21548	BT40H90K05-HTT	5	90	30	10	11	17	M6	2	•
251-21549	BT40H90K06-HTT	6	90	36	10	12	18	M5	2,5	•
251-21550	BT40H90K08-HTT	8	90	36	10	14	20	M6	3	•
251-21551	BT40H90K10-HTT	10	90	41	10	16	22	M8x1	3	•
251-21552	BT40H90K12-HTT	12	90	47	10	18	24	M10x1	5	•
251-21553	BT40H90K14-HTT	14	90	47	10	20	26	M10x1	5	•
251-21554	BT40H90K16-HTT	16	90	50	10	22	28	M12x1	5	•
251-21555	BT40H90K18-HTT	18	90	50	10	24	30	M12x1	5	•
251-21556	BT40H90K20-HTT	20	90	52	10	26	32	M16x1	8	•

SHRINK FIT CHUCKS MAS BT40 AD/B MANDRINI A CALETTAMENTO MAS BT40 TIPO AD/B  
 SCHRUMPFUTTER MAS BT40 FORM AD/B MANDRINS DE FRETTAGE MAS BT40 TYPE AD/B  
 ТЕРМОЗАЖИМНЫЕ ПАТРОНЫ MAS BT-40 ТИП AD/B 热缩刀柄 MAS BT40 AD/B

08

**JIS-B 6339 MAS 403 BT-AD/B - MAS BT**

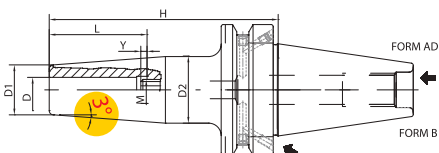

**3° PROGRAMME**

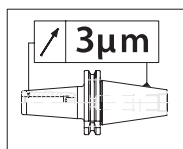

CODE N.	DESCRIPTION	D	H	L	Y <sub>max</sub>	D1	D2	M	SW	G2,5 25000
251-21557	BT40H120K03-HTT	3	120	12	-	9	16	-	-	•
251-21558	BT40H120K04-HTT	4	120	16	-	10	17	-	-	•
251-21559	BT40H120K05-HTT	5	120	20	-	11	18	-	-	•
251-21560	BT40H120K06-HTT	6	120	36	10	12	21	M5	2,5	•
251-21561	BT40H120K08-HTT	8	120	36	10	14	23	M6	3	•
251-21562	BT40H120K10-HTT	10	120	41	10	16	25	M8x1	3	•
251-21563	BT40H120K12-HTT	12	120	47	10	18	27	M10x1	5	•
251-21564	BT40H120K14-HTT	14	120	47	10	20	29	M10x1	5	•
251-21565	BT40H120K16-HTT	16	120	50	10	22	31	M12x1	5	•
251-21566	BT40H120K18-HTT	18	120	50	10	24	33	M12x1	5	•
251-21567	BT40H120K20-HTT	20	120	52	10	26	35	M16x1	8	•
251-21568	BT40H160K03-HTT	3	160	12	-	9	19	-	-	•
251-21569	BT40H160K04-HTT	4	160	16	-	10	20	-	-	•
251-21570	BT40H160K05-HTT	5	160	20	-	11	21	-	-	•
251-21571	BT40H160K06-HTT	6	160	36	10	12	24	M5	2,5	•
251-21572	BT40H160K08-HTT	8	160	36	10	14	26	M6	3	•
251-21573	BT40H160K10-HTT	10	160	41	10	16	28	M8x1	3	•
251-21574	BT40H160K12-HTT	12	160	47	10	18	30	M10x1	5	•
251-21575	BT40H160K14-HTT	14	160	47	10	20	32	M10x1	5	•
251-21576	BT40H160K16-HTT	16	160	50	10	22	34	M12x1	5	•
251-21577	BT40H160K18-HTT	18	160	50	10	24	36	M12x1	5	•
251-21578	BT40H160K20-HTT	20	160	52	10	26	38	M16x1	8	•



SHRINK FIT CHUCKS MAS BT50 AD/B MANDRINI A CALETTAMENTO MAS BT50 TIPO AD/B  
 SCHRUMPFUTTER MAS BT50 FORM AD/B MANDRINS DE FRETTAGE MAS BT50 TYPE AD/B  
 ТЕРМОЗАЖИМНЫЕ ПАТРОНЫ MAS BT-50 ТИП AD/B 热缩刀柄 MAS BT50 AD/B

## JIS-B 6339 MAS 403 BT-AD/B - MAS BT AD/B

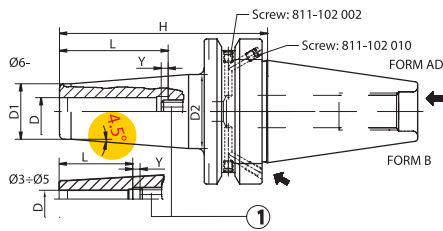

**4.5° PROGRAMME**

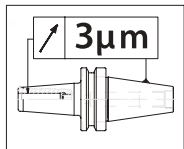

	CODE N.	DESCRIPTION	D	H	L	Y <sub>max</sub>	D1	D2	G2,5 25000
STANDARD	251-21522	BT50H100K03-HTT	3	100	-	-	10	20	•
	251-21523	BT50H100K04-HTT	4	100	-	-	15	25	•
	251-21524	BT50H100K05-HTT	5	100	-	-	15	25	•
	251-11548	BT50H100K06-HTT	6	100	36	10	21	27	•
	251-11549	BT50H100K08-HTT	8	100	36	10	21	27	•
	251-11550	BT50H100K10-HTT	10	100	41	10	24	32	•
	251-11517	BT50H100K12-HTT	12	100	47	10	24	32	•
	251-11551	BT50H100K14-HTT	14	100	47	10	27	34	•
	251-11552	BT50H100K16-HTT	16	100	50	10	27	42	•
	251-11553	BT50H100K18-HTT	18	100	50	10	33	42	•
H160	251-11554	BT50H110K20-HTT	20	100	52	10	33	42	•
	251-11555	BT50H110K25-HTT	25	110	58	10	44	53	•
	251-21525	BT50H110K32-HTT	32	110	62	10	44	53	•
	251-21535	BT50H160K08-HTT	8	160	36	10	21	27	•
	251-21536	BT50H160K10-HTT	10	160	41	10	24	3	•
	251-21537	BT50H160K12-HTT	12	160	47	10	24	32	•
	251-21539	BT50H160K16-HTT	16	160	50	10	27	34	•
	251-21540	BT50H160K18-HTT	18	160	50	10	33	42	•
	251-21541	BT50H160K20-HTT	20	160	52	10	33	42	•
	251-21542	BT50H160K25-HTT	25	160	58	10	44	53	•

SHRINK FIT CHUCKS HSK 63 DIN69893 TYPE A MANDRINI A CALETTAMENTO HSK 63 DIN 69893 TIPO A  
 SCHRUMPFUTTER HSK 63 DIN 69893 FORM A MANDRINS DE FRETTAGE TYPE HSK 63 DIN 69893 A  
 ТЕРМОЗАЖИМНЫЕ ПАТРОНЫ HSK 63 ПО DIN 69893 ТИП А 热缩刀柄 HSK 63 DIN 69893 A 型

## DIN 69893 - HSK 63A

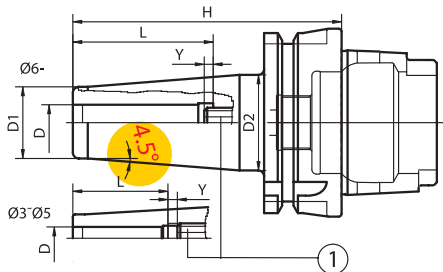

**4.5° PROGRAMME**

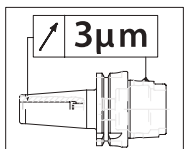

	CODE N.	DESCRIPTION	D	H	L	Y <sub>max</sub>	D1	D2	G2,5 25000
STANDARD	251-21725	HSK63AH80K03-HTT	3	80	14	10	10	15	•
	251-21726	HSK63AH80K04-HTT	4	80	18	10	15	22	•
	251-21727	HSK63AH80K05-HTT	5	80	22	10	15	22	•
	251-21728	HSK63AH80K06-HTT	6	80	36	10	21	27	•
	251-21729	HSK63AH80K08-HTT	8	80	36	10	21	27	•
	251-21730	HSK63AH85K10-HTT	10	85	42	10	24	32	•
	251-11710	HSK63AH90K12-HTT	12	90	47	10	24	32	•
	251-11711	HSK63AH90K14-HTT	14	90	47	10	27	34	•
	251-11712	HSK63AH95K16-HTT	16	95	50	10	27	34	•
	251-11713	HSK63AH95K18-HTT	18	95	50	10	33	42	•
H120	251-11714	HSK63AH100K20-HTT	20	100	52	10	33	42	•
	251-21731	HSK63AH115K25-HTT	25	115	58	10	44	53	•
	251-21782	HSK63AH120K32-HTT	32	120	62	10	44	53	•
	251-21732	HSK63AH120K03-HTT	3	120	22	10	10	20	•
	251-21733	HSK63AH120K04-HTT	4	120	26	10	15	22	•
	251-21734	HSK63AH120K05-HTT	5	120	30	10	15	22	•
	251-11725	HSK63AH120K06-HTT	6	120	36	10	21	27	•
	251-11726	HSK63AH120K08-HTT	8	120	36	10	21	27	•
	251-11727	HSK63AH120K10-HTT	10	120	41	10	24	32	•
	251-11728	HSK63AH120K12-HTT	12	120	47	10	24	32	•
H160	251-11729	HSK63AH120K14-HTT	14	120	47	10	27	34	•
	251-11730	HSK63AH120K16-HTT	16	120	50	10	27	34	•
	251-21783	HSK63AH120K18-HTT	18	120	50	10	33	42	•
	251-21784	HSK63AH120K20-HTT	20	120	52	10	33	42	•
	251-21785	HSK63AH120K25-HTT	25	120	58	10	44	53	•
	251-21786	HSK63AH160K03-HTT	3	160	22	10	10	20	•
	251-21787	HSK63AH160K04-HTT	4	160	26	10	15	22	•
	251-21788	HSK63AH160K05-HTT	5	160	30	10	15	22	•
	251-21789	HSK63AH160K06-HTT	6	160	36	10	21	27	•
	251-21790	HSK63AH160K08-HTT	8	160	36	10	21	27	•
251-21791	HSK63AH160K10-HTT	10	160	41	10	24	32	•	
251-21792	HSK63AH160K12-HTT	12	160	47	10	24	32	•	
251-21793	HSK63AH160K14-HTT	14	160	47	10	27	34	•	
251-21794	HSK63AH160K16-HTT	16	160	50	10	27	34	•	
251-21795	HSK63AH160K18-HTT	18	160	50	10	33	42	•	
251-21796	HSK63AH160K20-HTT	20	160	52	10	33	42	•	
251-21797	HSK63AH160K25-HTT	25	160	62	10	44	53	•	
251-21798	HSK63AH160K32-HTT	32	160	62	10	44	53	•	

SHRINK FIT CHUCKS HSK 63 DIN69893 TYPE A MANDRINI A CALETTAMENTO HSK 63 DIN 69893 TIPO A  
 SCHRUMPFUTTER HSK 63 DIN 69893 FORM A MANDRINS DE FRETTAGE TYPE HSK 63 DIN 69893 A  
 ТЕРМОЗАЖИМНЫЕ ПАТРОНЫ HSK 63 ПО DIN 69893 ТИП А 热缩刀柄 HSK 63 DIN 69893 A 型

## DIN 69893A

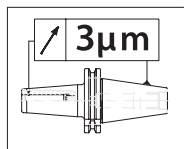
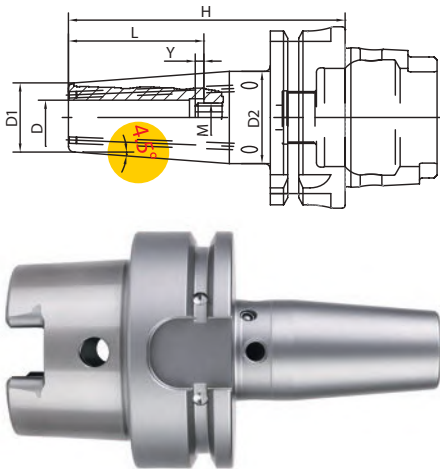

**4,5° PROGRAMME WITH RESEALABLE COOLANT DUCT HOLES**  
**4,5° CON PASSAGGIO REFRIGERANTE MEDIANTE CANALI ESTERNI RICHIUDIBILI**

CODE N.	DESCRIPTION	D	H	L	Y <sub>max</sub>	D1	D2	M	SW	G2,5 25000
251-31760	HSK63AH80K03-HTT-L	3	80	28	16	10	15	M6	2	•
251-31761	HSK63AH80K04-HTT-L	4	80	28	12	15	22	M6	2	•
251-31762	HSK63AH80K05-HTT-L	5	80	30	10	15	22	M6	2	•
251-31763	HSK63AH80K06-HTT-L	6	80	36	10	21	27	M5	2,5	•
251-31764	HSK63AH80K08-HTT-L	8	80	36	10	21	27	M6	3	•
251-31765	HSK63AH85K10-HTT-L	10	85	41	10	24	32	M8x1	3	•
251-31766	HSK63AH90K12-HTT-L	12	90	47	10	24	32	M10x1	5	•
251-31767	HSK63AH90K14-HTT-L	14	90	47	10	27	34	M10x1	5	•
251-31768	HSK63AH95K16-HTT-L	16	95	50	10	27	34	M12x1_KKB	5	•
251-31769	HSK63AH95K18-HTT-L	18	95	50	10	33	42	M12x1_KKB	5	•
251-31770	HSK63AH100K20-HTT-L	20	100	52	10	33	42	M16x1_KKB	5	•
251-31771	HSK63AH115K25-HTT-L	25	115	58	10	44	53	M16x1_KKB	5	•
251-31772	HSK63AH120K32-HTT-L	32	120	62	10	44	53	M16x1_KKB	5	•

SHRINK FIT CHUCKS HSK 63 DIN69893 TYPE A MANDRINI A CALETTAMENTO HSK 63 DIN 69893 TIPO A  
 SCHRUMPFUTTER HSK 63 DIN 69893 FORM A MANDRINS DE FRETTAGE TYPE HSK 63 DIN 69893 A  
 ТЕРМОЗАЖИМНЫЕ ПАТРОНЫ HSK 63 ПО DIN 69893 ТИП А 热缩刀柄 HSK 63 DIN 69893 A 型

## DIN 69893A - HSKA1

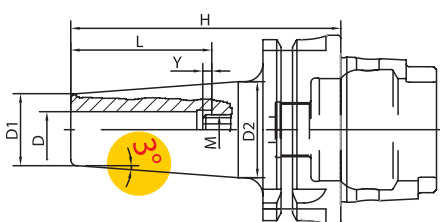

**3° PROGRAMME**

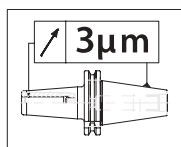

CODE N.	DESCRIPTION	D	H	L	Y <sub>max</sub>	D1	D2	M	SW	G2,5 25000
251-31711	HSK63AH80K03-HTT	3	80	28	16	9	14	M6	2	•
251-31712	HSK63AH80K04-HTT	4	80	28	12	10	15	M6	2	•
251-31713	HSK63AH80K05-HTT	5	80	30	10	11	16	M6	2	•
251-31714	HSK63AH80K06-HTT	6	80	36	10	12	17	M5	2,5	•
251-31715	HSK63AH80K08-HTT	8	80	36	10	14	19	M6	3	•
251-31716	HSK63AH85K10-HTT	10	85	41	10	16	21	M8x1	3	•
251-31717	HSK63AH90K12-HTT	12	90	47	10	18	24	M10x1	5	•
251-31718	HSK63AH90K14-HTT	14	90	47	10	20	26	M10x1	5	•
251-31719	HSK63AH95K16-HTT	16	95	50	10	22	28	M12x1	5	•
251-31720	HSK63AH95K18-HTT	18	95	50	10	24	30	M12x1	5	•
251-31721	HSK63AH100K20-HTT	20	100	52	10	26	32	M16x1	8	•

SHRINK FIT CHUCKS HSK 63 DIN69893 TYPE A    MANDRINI A CALETTAMENTO HSK 63 DIN 69893 TIPO A  
 SCHRUMPFUTTER HSK 63 DIN 69893 FORM A    MANDRINS DE FRETTAGE TYPE HSK 63 DIN 69893 A  
 ТЕРМОЗАЖИМНЫЕ ПАТРОНЫ HSK 63 ПО DIN 69893 ТИП А    热缩刀柄 HSK 63 DIN 69893 A 型

### DIN 69893A - HSKA2

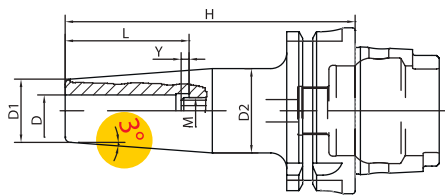

**3° PROGRAMME**

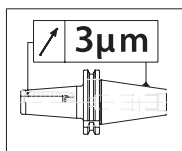

	CODE N.	DESCRIPTION	D	H	L	Y <sub>max</sub>	D1	D2	M	SW	G2,5 25000
H120	251-31722	HSK63AH120K03-HTT	3	120	12	-	9	16	-	-	•
	251-31723	HSK63AH120K04-HTT	4	120	16	-	10	17	-	-	•
	251-31724	HSK63AH120K05-HTT	5	120	20	-	11	18	-	-	•
	251-31725	HSK63AH120K06-HTT	6	120	36	10	12	21	M5	2,5	•
	251-31726	HSK63AH120K08-HTT	8	120	36	10	14	23	M6	3	•
	251-31727	HSK63AH120K10-HTT	10	120	41	10	16	25	M8x1	3	•
	251-31728	HSK63AH120K12-HTT	12	120	47	10	18	27	M10x1	5	•
	251-31729	HSK63AH120K14-HTT	14	120	47	10	20	29	M10x1	5	•
	251-31730	HSK63AH120K16-HTT	16	120	50	10	22	31	M12x1	5	•
	251-31731	HSK63AH120K18-HTT	18	120	50	10	24	33	M12x1	5	•
251-31732	HSK63AH120K20-HTT	20	120	52	10	26	35	M16x1	8	•	
H160	251-31733	HSK63AH160K03-HTT	3	160	12	-	9	19	-	-	•
	251-31734	HSK63AH160K04-HTT	4	160	16	-	10	20	-	-	•
	251-31735	HSK63AH160K05-HTT	5	160	20	-	11	21	-	-	•
	251-31736	HSK63AH160K06-HTT	6	160	36	10	12	24	M5	2,5	•
	251-31737	HSK63AH160K08-HTT	8	160	36	10	14	26	M6	3	•
	251-31738	HSK63AH160K10-HTT	10	160	41	10	16	28	M8x1	3	•
	251-31739	HSK63AH160K12-HTT	12	160	47	10	18	30	M10x1	5	•
	251-31740	HSK63AH160K14-HTT	14	160	47	10	20	32	M10x1	5	•
	251-31741	HSK63AH160K16-HTT	16	160	50	10	22	34	M12x1	5	•
	251-31742	HSK63AH160K18-HTT	18	160	50	10	24	36	M12x1	5	•
251-31743	HSK63AH160K20-HTT	20	160	52	10	26	38	M16x1	8	•	

08

SHRINK FIT CHUCKS HSK 100 DIN69893 TYPE A    MANDRINI A CALETTAMENTO HSK 100 DIN 69893 TIPO A  
 SCHRUMPFUTTER HSK 100 DIN 69893 FORM A    MANDRINS DE FRETTAGE TYPE HSK 100 DIN 69893 A  
 АТЕРМОЗАЖИМНЫЕ ПАТРОНЫ HSK 100 ПО DIN 69893 ТИП А    热缩刀柄 HSK 100 DIN 69893 A 型

### DIN 69893 - HSK 100A

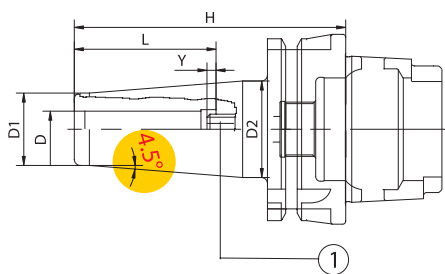

**4.5° PROGRAMME**

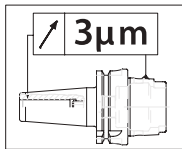

	CODE N.	DESCRIPTION	D	H	L	Y <sub>max</sub>	D1	D2	G2,5 25000
STANDARD	251-21735	HSK100AH85K06-HTT	6	85	36	10	21	27	•
	251-21736	HSK100AH85K08-HTT	8	85	36	10	21	27	•
	251-21737	HSK100AH90K10-HTT	10	90	41	10	24	32	•
	251-21738	HSK100AH95K12-HTT	12	95	47	10	24	32	•
	251-21739	HSK100AH95K14-HTT	14	95	47	10	27	34	•
	251-21740	HSK100AH100K16-HTT	16	100	50	10	27	34	•
	251-21742	HSK100AH105K20-HTT	20	105	52	10	33	42	•
	251-21743	HSK100AH115K25-HTT	25	115	58	10	44	53	•
251-21799	HSK100AH120K32-HTT	32	120	62	10	44	53	•	
EXTENDED	251-21744	HSK100AH120K06-HTT	6	120	36	10	21	27	•
	251-21745	HSK100AH120K08-HTT	8	120	36	10	21	27	•
	251-21746	HSK100AH120K10-HTT	10	120	41	10	24	32	•
	251-21747	HSK100AH120K12-HTT	12	120	47	10	24	32	•
	251-21748	HSK100AH120K14-HTT	14	120	47	10	27	34	•
	251-21749	HSK100AH120K16-HTT	16	120	50	10	27	34	•
	251-21751	HSK100AH120K20-HTT	20	120	52	10	33	42	•
	251-31701	HSK100AH160K25-HTT	25	160	58	10	44	53	•
251-31702	HSK100AH160K32-HTT	32	160	62	10	44	53	•	

SHRINK FIT CHUCKS HSK 100 DIN69893 TYPE MANDRINI A CALETTAMENTO HSK 100 DIN 69893 TIPO A  
 SCHRUMPFUTTER HSK 100 DIN 69893 FORM A MANDRINS DE FRETTAGE TYPE HSK 100 DIN 69893 A  
 АТЕРМОЗАЖИМНЫЕ ПАТРОНЫ HSK 100 ПО DIN 69893 ТИП А 热缩刀柄 HSK 100 DIN 69893 A 型

## DIN 69893 - HSKA1

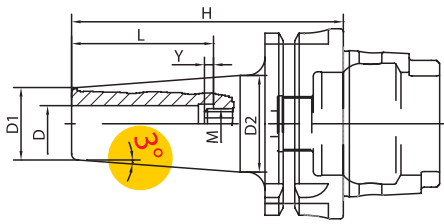

**3° PROGRAMME**

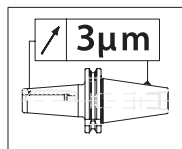

	CODE N.	DESCRIPTION	D	H	L	Y <sub>max</sub>	D1	D2	M	SW	G2,5 25000
STANDARD	251-31744	HSK100AH85K06-HTT	6	85	36	10	12	17	M5	2,5	•
	251-31745	HSK100AH85K08-HTT	8	85	36	10	14	19	M6	3	•
	251-31746	HSK100AH90K10-HTT	10	90	41	10	16	21	M8x1	3	•
	251-31747	HSK100AH95K12-HTT	12	95	47	10	18	24	M10x1	5	•
	251-31748	HSK100AH95K14-HTT	14	95	47	10	20	26	M10x1	5	•
	251-31749	HSK100AH100K16-HTT	16	100	50	10	22	28	M12x1	5	•
	251-31750	HSK100AH100K18-HTT	18	100	50	10	24	30	M12x1	5	•
	251-31751	HSK100AH105K20-HTT	20	105	52	10	27	34	M16x1	8	•

SHRINK FIT CHUCKS HSK 100 DIN69893 TYPE MANDRINI A CALETTAMENTO HSK 100 DIN 69893 TIPO A  
 SCHRUMPFUTTER HSK 100 DIN 69893 FORM A MANDRINS DE FRETTAGE TYPE HSK 100 DIN 69893 A  
 АТЕРМОЗАЖИМНЫЕ ПАТРОНЫ HSK 100 ПО DIN 69893 ТИП А 热缩刀柄 HSK 100 DIN 69893 A 型

## DIN 69893 - HSKA2

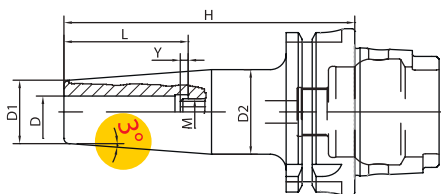

**3° PROGRAMME**

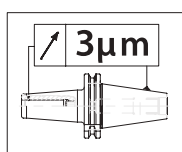

	CODE N.	DESCRIPTION	D	H	L	Y <sub>max</sub>	D1	D2	M	SW	G2,5 25000
H120	251-31752	HSK100AH120K06-HTT	6	120	36	10	12	20	M5	2,5	•
	251-31753	HSK100AH120K08-HTT	8	120	36	10	14	22	M6	3	•
	251-31754	HSK100AH120K10-HTT	10	120	41	10	16	24	M8x1	3	•
	251-31755	HSK100AH120K12-HTT	12	120	47	10	18	26	M10x1	5	•
	251-31756	HSK100AH120K14-HTT	14	120	47	10	20	28	M10x1	5	•
	251-31757	HSK100AH120K16-HTT	16	120	50	10	22	30	M12x1	5	•
	251-31758	HSK100AH120K18-HTT	18	120	50	10	24	32	M12x1	5	•
	251-31759	HSK100AH120K20-HTT	20	120	52	10	27	35	M16x1	8	•

SHRINK FIT CHUCKS HSK 63 DIN69893 TYPE E MANDRINI A CALETTAMENTO HSK 63 DIN 69893 TIPO E  
 SCHRUMPFUTTER HSK 63 DIN 69893 FORM E MANDRINS DE FRETTAGE TYPE HSK 63 DIN 69893 E  
 ТЕРМОЗАЖИМНЫЕ ПАТРОНЫ HSK 63 ПО DIN 69893 ТИП E 热缩刀柄 HSK 63 DIN 69893 E 型

DIN 69893 - HSK 63E

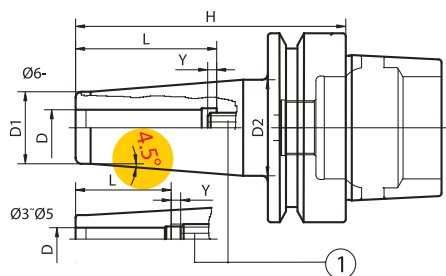

4.5° PROGRAMME

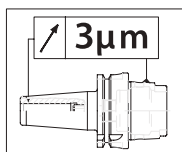

	CODE N.	DESCRIPTION	D	H	L	Y <sub>max</sub>	D1	D2	G2,5 25000
STANDARD	251-27333	HSK63EH80K03-HTT	3	80	22	10	10	15	•
	251-27334	HSK63EH80K04-HTT	4	80	26	10	15	22	•
	251-27335	HSK63EH80K05-HTT	5	80	30	10	15	22	•
	251-27336	HSK63EH80K06-HTT	6	80	36	10	21	27	•
	251-27337	HSK63EH80K08-HTT	8	80	36	10	21	27	•
	251-27338	HSK63EH85K10-HTT	10	85	41	10	24	32	•
	251-17310	HSK63EH90K12-HTT	12	90	47	10	24	32	•
	251-17311	HSK63EH90K14-HTT	14	90	47	10	27	34	•
	251-17312	HSK63EH95K16-HTT	16	95	50	10	27	34	•
	251-17313	HSK63EH95K18-HTT	18	95	50	10	33	42	•
	251-17314	HSK63EH100K20-HTT	20	100	52	10	33	42	•
	251-27339	HSK63EH115K25-HTT	25	115	58	10	44	53	•
	251-27356	HSK63EH115K32-HTT	32	120	62	10	44	53	•

08

SHRINK FIT CHUCKS HSK 50 DIN69893 TYPE E MANDRINI A CALETTAMENTO HSK 50 DIN 69893 TIPO E  
 SCHRUMPFUTTER HSK 50 DIN 69893 FORM E MANDRINS DE FRETTAGE TYPE HSK 50 DIN 69893 E  
 ТЕРМОЗАЖИМНЫЕ ПАТРОНЫ HSK 50 ПО DIN 69893 ТИП E 热缩刀柄 HSK 50 DIN 69893 E 型

DIN 69893E - HSKE

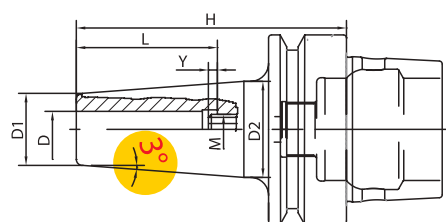

3° PROGRAMME

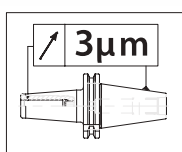

	CODE N.	DESCRIPTION	D	H	L	Y <sub>max</sub>	D1	D2	M	SW	G2,5 25000
H80	251-27368	HSK50EH80K03-HTT	3	80	28	16	9	15	M6	2	•
	251-27369	HSK50EH80K04-HTT	4	80	28	12	10	16	M6	2	•
	251-27370	HSK50EH80K05-HTT	5	80	30	10	11	17	M6	2	•
	251-27371	HSK50EH80K06-HTT	6	80	36	10	12	18	M5	2,5	•
	251-27372	HSK50EH80K08-HTT	8	80	36	10	14	20	M6	3	•
	251-27373	HSK50EH80K10-HTT	10	80	41	10	16	22	M5	2,5	•
	251-27374	HSK50EH80K12-HTT	12	80	47	10	18	24	M5	2,5	•
H80	251-27375	HSK63EH80K06-HTT	6	80	36	10	12	18	M5	2,5	•
	251-27376	HSK63EH80K08-HTT	8	80	36	10	14	20	M6	3	•
	251-27377	HSK63EH80K10-HTT	10	80	41	10	16	22	M5	2,5	•
	251-27378	HSK63EH80K12-HTT	12	80	47	10	18	24	M5	2,5	•

SHRINKING EXTENSIONS    PROLUNGHE PER CALETTAMENTO  
 SCHRUMPFVERLÄNGERUNGEN    RALLONGES DE FRETTAGE  
 ТЕРМОЗАЖИМНЫЕ УДЛИНИТЕЛИ    热缩延长杆

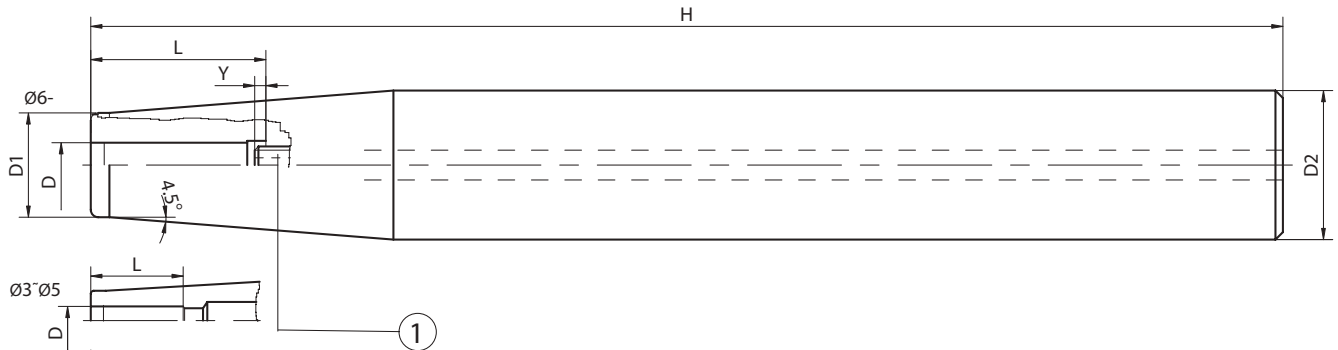

CODE N.	DESCRIPTION	D	H	L	Y max	D1	D2
251-15110	D12H150K03-HTT	3	150	-	-	8	12
251-15111	D12H150K04-HTT	4	150	-	-	8	12
251-15133	D12H150K05-HTT	5	150	-	-	10	12
251-15134	D12H150K06-HTT	6	150	36	10	10	12
251-15112	D16H150K03-HTT	3	150	-	-	10	16
251-15113	D16H150K04-HTT	4	150	-	-	10	16
251-15114	D16H150K05-HTT	5	150	-	-	10	16
251-15115	D16H150K06-HTT	6	150	36	10	10	16
251-15139	D16H150K08-HTT	8	150	36	10	12	16
251-15140	D20H150K03-HTT	3	150	-	-	10	20
251-15141	D20H150K04-HTT	4	150	-	-	10	20
251-15117	D20H150K06-HTT	6	150	36	10	10	20
251-15118	D20H150K08-HTT	8	150	36	10	12	20
251-15145	D20H150K10-HTT	10	150	42	10	14	20
251-15146	D20H150K12-HTT	12	150	47	10	16	20
251-15147	D25H150K03-HTT	3	150	-	-	10	25
251-15148	D25H150K04-HTT	4	150	-	-	10	25
251-15149	D25H150K05-HTT	5	150	-	-	15	25
251-15150	D25H150K06-HTT	6	150	36	10	20	25
251-15119	D25H150K08-HTT	8	150	36	10	20	25
251-15120	D25H150K10-HTT	10	150	42	10	20	25
251-15121	D25H150K12-HTT	12	150	47	10	20	25
251-15122	D25H150K14-HTT	14	150	47	10	20	25
251-15123	D25H150K16-HTT	16	150	50	10	22	25